

**GOODRICH**

**DELAVAN**<sup>®</sup>  
Spray Technologies

# SDX Spray Drying

Product Guide

# SDX





# Nozzles for use in Spray Drying

## The Quality you've come to expect

Delavan Spray Drying Nozzles reflect years of dedication to quality, flexibility and reliability. Since 1935, the Delavan name has become synonymous with precision engineering, proven techniques and product satisfaction. Today Delavan continues to be a leader in the spray drying industry by staying at the forefront of research and development in new materials, delivery systems and designs to handle new challenges across a range of industries.

### High Performance – Rugged Durability

Delavan Spray Drying Nozzles set the standard by which other nozzles are judged. We held the first patent on the revolutionary swirl chamber design, with a single inlet, which minimises plugging and maximises particle uniformity. This design has improved dry product quality because the spiral configuration conforms to the natural path of liquid as it progresses toward the orifice.

#### In addition, Delavan offers:-

- **Durability and wear resistance**

Our nozzles are available in materials that resist chemical attack such as plastics, ceramics, sintered carbides and various grades of stainless steel.

- **Customisation**

To suit all your application needs, you can specify spray characteristics to meet your needs, including droplet size and particle size, spray angle, flow variation and properties of the liquid being sprayed

- **Versatility**

Delavan offers three swirl chamber designs with orifice discs ranging in size from 0.4mm to 6.4mm. The large number of swirl chamber and orifice combinations provide customers with more options when spray drying a variety of different products. Swirl chambers and orifices can be paired in a variety of combinations to produce the droplet size, flow rate, and spray angle and product quality needed to meet your exact product specifications.

- **Technical expertise and know how**

Understanding the "custom" aspect of each application is of critical importance in spray drying. Almost every dryer presents a unique situation depending on feed material, capacity, and operating conditions. Delavan understands the conditions and problems inherent in spray drying and will recommend the right nozzle for the best performance.

#### Our Technical support includes:-

- **Lifetime service and support**

Once Delavan nozzles are installed in your dryer, the support never ends. You can contact Delavan at any time with changes, questions or issues

- **Computer Analysis**

To suit all your application requirements, Delavan uses computer analysis programs to produce information such as droplet size, spray angle, flow rate – all this before installing any nozzles into the spray dryer, saving valuable time and money.

Whilst the flagship of the SDX range is the latest version of the SDX V nozzle, the original classic designs are all still available as are all of the wear parts within the Delavan range. New manufacturing equipment and tooling improvements mean that the excellent quality of the product has been further improved and deliveries are now being made from the main production facility in the UK. The recent installation of a laser marking system has provided for the very high quality identification of wear parts and new packaging has been developed to ensure that all genuine Delavan SDX components reach their destination in pristine condition.

Delavan remains committed to providing its customers with high quality, reliable delivery and the kind of performance expected from the technology leader.



## ...the critical factors affecting the spray quality.

### The Atomiser

Delavan recognises that at the "heart" of any spray dryer is the atomiser, small in size, big in importance, installing the right atomiser is essential to spray drying success.

#### The atomiser must fulfil several important functions.

1. It must disperse the feed material into small droplets, which should be well distributed within the dryer and mixed thoroughly with the hot gas.
2. The size of the droplets produced must be compatible with the required product particle size characteristics,
3. The droplets produced must not be so large that they are incompletely dried, nor so small that product recovery is difficult. Small particles may also overheat and become scorched.
4. The atomiser must also act as a metering device, controlling the rate at which the material is fed into the dryer.

Consequently, the atomiser, though relatively inexpensive, is therefore an extremely critical element.

#### Centrifugal Pressure Nozzles

The SDX™ nozzle represents Delavan's range of centrifugal spray drying nozzles. Energy for atomisation is supplied solely by the feed liquid pressure, with pressures up to 700 bar being used.

The SDX™ range is of the swirl type configuration using a single inlet swirl chamber and has the capability of atomising liquids having viscosities up to several hundred centipoise.

All the SDX™ nozzles uses a similar design swirl configuration with orifice discs, thereby guaranteeing uniformity of performance across the range.

#### Two-Fluid Nozzles

In two-fluid nozzles, gas (or steam) supplies most of the energy required to atomise the liquid. Liquid admitted under low pressure may be mixed either internally or externally with the gas. Although energy requirements for this atomiser are generally greater than the spinning disks or pressure nozzles, the two-fluid nozzle can produce very fine atomisation, particularly with viscous materials. It is often used in laboratory and small spray dryers.

#### Spray Quality and Particle Size

Whilst durability is one of the foremost requirements of pressure nozzles, atomisation quality is certainly just as critical. The importance of droplet size is often more critical than in other spray operations. Droplet size affects not only dryer size and operating efficiency, but also the characteristics of the final product.

Particle size is critical with regard to bulk density, solubility and customer acceptance.

Distinguishing between droplet size and particle size is important, since the two are generally not identical, although the relationship between the two can often be determined, usually by on-site trials.

Particle size, or droplet size is usually expressed in terms of a mean or average diameter as well as the range or spread in size. As discussed in Delavan's "Spray Droplet Technology" booklet, there are several definitions of mean diameter.

#### Droplet Diameters

Delavan uses the Sauter mean diameter, whose ratio of volume to surface area is equal to that of the aggregate spray, to measure the droplet diameter. The range or spread in droplet size requires an understanding of the entire distribution.

Typically, a spray drying nozzle will produce droplets as small as 1 to 2 micron and as large as 400 to 500 micron. However, the majority will be within a range of 50-200 micron. The narrower the range of droplet size the more suited it is to spray drying, with a "mono-range" being the ultimate goal for most operators.

#### Spray Angle

The spray angle in spray drying is usually in the 60° to 90° band. It must be noted that the spray angle measured near the orifice may not prevail further away. This is particularly true at high pressures, when the angle becomes actually narrower within a short distance. Therefore it is important to establish the exact manner in which this spray angle is measured.

#### Flow Variation

SDX nozzles may also act as metering devices, controlling the distribution of feed into the chamber. Whether single or multi - nozzle application are used the flow rate must be precisely controlled to be compatible with the dryer design.

It is important therefore to understand the properties of the feed material.

As there are so many different feed stocks, all of Delavan's calculations are based on water and variations of viscosity etc. are taken into account in Delavan's computer analysis programmes.

#### Liquid Properties

Understanding of the feed stock is essential. The properties of the feed stock are directly related to the finished particle size, therefore density, viscosity, percentage solids, abrasive awareness and any other characteristics all need to be considered

The liquid properties should be established at the temperature corresponding to the liquid in the nozzle. Feed stocks are often sprayed at elevated temperatures to decrease viscosity, thereby improving atomisation.

The effect of each liquid property on droplet size is usually established by actual test, however Delavan's field experience shows that these effects can be closely estimated from the following correction factors:

<b>EFFECT OF LIQUID VISCOSITY</b>	<b><math>D \propto m^{0.25}</math></b>
	Where <b>D</b> = Mean droplet diameter, micrometers <b>m</b> = Absolute viscosity, centipoise
	<b><math>D \propto s^{0.33}</math></b>
	Where <b>s</b> = Surface tension, dynes/cm

#### Wear Resistance

The wear life of the internal parts (consumable parts), depends upon its corrosion and erosion resistant characteristics

Corrosion occurs when the liquid feed and wear parts are chemically incompatible.

Erosion results from the liquid feed with its abrasive solids physically removing the material.

Corrosion problems can be avoided if the chemical properties of the feed stock are known and the material of the consumable parts are designed to be compatible.

Erosion can be combated, but never fully overcome. The use of harder material, or special materials can reduce this problem.



# SDX™ Product Range

## Overview

For over three decades, Delavan the leader in the spray dry industry, continues the tradition with the original SDX™ family of products. This product line specifically designed for the spray drying industry includes five centrifugal pressure nozzles; the SDX, SDX III, SDX V, Mini SDX and SDX Compact. Each of these five products is built on Delavan's unique single inlet spiral swirl chamber design and highly polished orifice. This combination swirl chamber and orifice produces a limitless number of combinations to supply virtually any flow rate and spray angle. This means the nozzle can be "Fine Tuned" to almost any dryer or application.

Each SDX product incorporates a single inlet design which enhances the nozzles performance by minimizing plugging and maximizing particle uniformity. The automated polishing process controls the diameter of each orifice to within plus or minus 1/1000 of an inch ensuring incomparable spray performance. The key to the SDX's success is its spray quality and particle size creating a narrow band of droplet sizes. The nozzles internal design atomizes liquids having viscosities up to several hundred centipoise. The SDX is well suited to counter flow spray dryers and to installations requiring multiple atomizers. Optimum production capacities up to 10,000 pounds per hour through a single nozzle are possible.

### SDX™ Benefits:

This patented design offers several features recognized by the Spray Dry Industry worldwide. This centrifugal pressure atomizer produces a hollow cone spray pattern using pump fed pressures up to 10,000psi {690 bar}.

Specific benefits vary with each product and dryer, but common results include;

- Lower Dryer Inlet Temperatures,
  - Less Plugging,
  - Improved Product Quality,
  - Increased Throughput,
  - Longer Wear Life,
  - Atomizes Difficult Products,
  - Close Dimensional Tolerances, and Simplicity in design.
- Reduced Pump Pressure,

## SDX



### Features

This classic eight part construction nozzle is made from Stainless Steel using a standard endplate, swirl chamber and orifice metering set in tungsten carbide with a variety of seal materials. Torque tightened assembly required for a maximum design pressure 7,000 psi {690 bar} and temperature of 1,000° F {538 ° C} with metal seals.

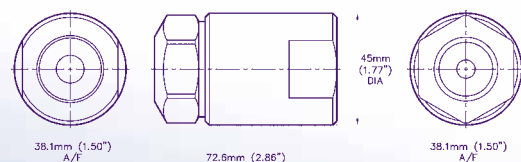

## SDX III



### Features

This simple six part construction nozzle is made from Stainless Steel using a standard endplate, swirl chamber and orifice metering set in tungsten carbide with Silicone or Viton o-ring. Hand tight assembly with a maximum design pressure of 5,000 psig {345 bar} and temperature of 300° F {149° C}. A further derivative capable of operation at 700 bar (10,000 psi) is also available.

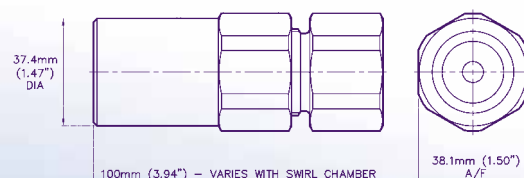

## SDX V

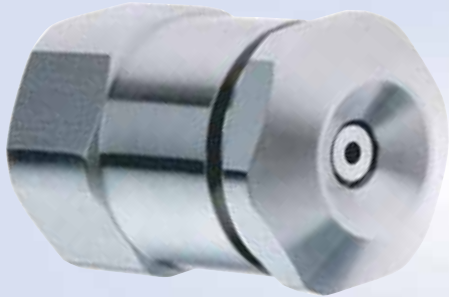

### Features

This cassette style eight part construction nozzle is made from Stainless Steel using retaining ring, single thickness swirl chamber and self-aligned orifice metering set in tungsten carbide with Viton or Silicone o-ring. Hand tight assembly with a maximum design pressure of 5,000 psig {345 bar} and temperature of 300° F {149° C}.

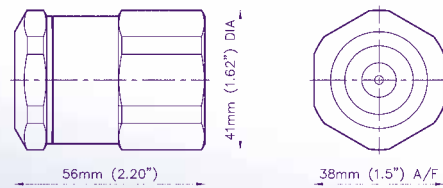

## MINI SDX



### Features

This low flow five part construction nozzle is made from Stainless Steel using a mini swirl chamber and mini orifice metering set in tungsten carbide with a Viton o-ring. Hand tight assembly with mini-sdx tool for a maximum design pressure 5,000 psig {345 bar} and temperature of 300° F {149° C}.

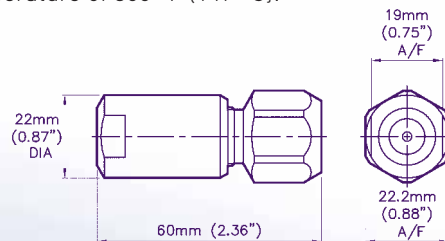

## Compact SDX



### Features

This simplified cassette style seven part construction nozzle is made from stainless steel using a mini single thickness swirl chamber and mini self-aligned orifice metering set in tungsten carbide with Viton o-rings or Silicon. Hand tight assembly with a maximum design pressure of 5,000 psig {345 bar} and temperature of 300° F {149° C}.

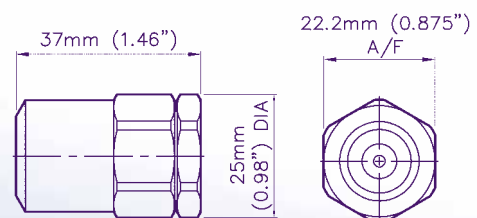

# Capacity Chart

Metering Sets					Spray Angle	SDX, SDX III, SDX V, MINI SDX and Compact SDX Capacity Chart										
Swirl Chamber				Orifice		Measured (1000 PSIG) with water	Flow rate in Litres/ HR at Bar G					Flow rate in US GPH at PSIG				
Mini SDX	Compact SDX	SDX & SDX III	SDX V				Equivalent Orifice Dia. (in)	69	138	207	276	345	1000	2000	3000	4000
SW4	-	-	-	0.016	70°-75°	21.2	29.9	36.7	42.4	47.3	5.6	7.9	9.7	11.2	12.5	
SW4	-	-	-	0.018	70°-75°	24.2	34.4	42.0	48.4	54.1	6.4	9.1	11.1	12.8	14.3	
SW4	-	-	-	0.020	70°-75°	25.7	36.3	44.7	51.5	57.5	6.8	9.6	11.8	13.6	15.2	
SW4	-	-	-	0.022	70°-75°	28.4	40.1	49.2	56.8	63.6	7.5	10.6	13.0	15.0	16.8	
SW4	-	-	-	0.024	70°-75°	32.6	46.2	56.4	65.1	72.7	8.6	12.2	14.9	17.2	19.2	
-	SAC	SA	SAV	0.025	68°	51.1	72.3	88.6	102.2	114.3	13.5	19.1	23.4	27.0	30.2	
SW1	-	-	-	0.027	70°-75°	54.9	77.6	95.0	109.8	122.6	14.5	20.5	25.1	29.0	32.4	
-	SAC	SA	SAV	0.028	71°	56.8	80.2	98.4	113.6	126.8	15.0	21.2	26.0	30.0	33.5	
SW1	-	-	-	0.030	70°-75°	62.5	88.2	108.3	124.9	139.7	16.5	23.3	28.6	33.0	36.9	
-	SAC	SA	SAV	0.031	74°	62.5	88.2	108.3	124.9	139.7	16.5	23.3	28.6	33.0	36.9	
SW1	-	-	-	0.033	70°-75°	65.9	93.1	113.9	131.7	147.2	17.4	24.6	30.1	34.8	38.9	
-	SAC	SA	SAV	0.034	77°	68.1	96.5	118.1	136.3	152.2	18.0	25.5	31.2	36.0	40.2	
SW1	-	-	-	0.036	70°-75°	71.2	100.7	123.4	142.3	159.0	18.8	26.6	32.6	37.6	42.0	
-	SAC	SA	SAV	0.037	79°	75.7	107.1	131.0	151.4	169.2	20.0	28.3	34.6	40.0	44.7	
SW2	-	-	-	0.038	70°-75°	100.3	141.9	177.5	200.6	224.5	26.5	37.5	46.9	53.0	59.3	
-	SBC	SB	SBV	0.040	76°	94.6	134.0	163.9	189.3	211.6	25.0	35.4	43.3	50.0	55.9	
SW2	-	-	-	0.042	70°-75°	113.6	160.5	196.8	227.1	254.0	30.0	42.4	52.0	60.0	67.1	
-	SBC	SB	SBV	0.043	78°	104.1	147.2	180.2	208.2	232.8	27.5	38.9	47.6	55.0	61.5	
SW2	-	-	-	0.044	70°-75°	119.2	168.4	206.7	238.5	266.5	31.5	44.5	54.6	63.0	70.4	
-	SBC	SB	SBV	0.046	80°	113.6	160.5	196.8	227.1	254.0	30.0	42.4	52.0	60.0	67.1	
SW2	-	-	-	0.048	70°-75°	132.5	187.4	227.9	265.0	296.4	35.0	49.5	60.2	70.0	78.3	
-	SBC	SB	SBV	0.049	81°	121.1	171.1	209.7	242.2	271.0	32.0	45.2	55.4	64.0	71.6	
SW2	-	-	-	0.050	70°-75°	140.0	198.0	242.6	280.1	313.0	37.0	52.3	64.1	74.0	82.7	
-	SBC	SB	SBV	0.052	82°	128.7	182.1	222.9	257.4	287.7	34.0	48.1	58.9	68.0	76.0	
SW3	-	-	-	0.054	70°-75°	191.1	270.2	331.2	382.3	389.5	50.5	71.4	87.5	101.0	102.9	
-	SCC	SC	SCV	0.055	78°	170.3	240.7	294.9	340.7	382.3	45.0	63.6	77.9	90.0	101.0	
SW3	-	-	-	0.056	70°-75°	202.5	286.5	350.9	405.0	452.7	53.5	75.7	92.7	107.0	119.6	
-	SCC	SC	SCV	0.058	79°	181.7	257.0	314.5	363.4	405.0	48.0	67.9	83.1	96.0	107.0	
SW3	-	-	-	0.060	70°-75°	219.5	310.4	380.0	439.1	490.9	58.0	82.0	100.4	116.0	129.7	
-	SCC	SC	SCV	0.061	80°	193.0	272.9	334.2	386.1	431.5	51.0	72.1	88.3	102.0	114.0	
SW3	-	-	-	0.062	70°-75°	230.9	326.6	400.1	461.8	516.3	61.0	86.3	105.7	122.0	136.4	
-	SCC	SC	SCV	0.064	81°	202.5	286.1	350.9	405.0	454.2	53.5	75.6	92.7	107.0	120.0	
-	SCC	SC	SCV	0.067	82°	212.0	299.8	367.1	423.9	473.1	56.0	79.2	97.0	112.0	125.0	
-	SCC	SC	SCV	0.070	83°	225.2	318.3	389.9	450.4	503.4	59.5	84.1	103.0	119.0	133.0	
-	SDC	SD	SDV	0.073	78°	291.4	412.6	503.4	582.9	651.0	77.0	109.0	133.0	154.0	172.0	
-	SDC	SD	SDV	0.076	79°	310.4	439.1	537.5	620.7	692.7	82.0	116.0	142.0	164.0	183.0	
-	SDC	SD	SDV	0.079	80°	325.5	461.8	564.0	651.0	726.7	86.0	122.0	149.0	172.0	192.0	
-	SDC	SD	SDV	0.082	81°	336.9	476.9	582.9	673.7	753.2	89.0	126.0	154.0	178.0	199.0	
-	SDC	SD	SDV	0.085	82°	348.2	492.1	601.8	696.4	779.7	92.0	130.0	159.0	184.0	206.0	
-	SDC	SD	SDV	0.088	83°	363.4	514.8	628.3	726.7	813.8	96.0	136.0	166.0	192.0	215.0	
-	-	SE	SEV	0.091	78°	469.3	662.4	813.8	938.7	1,048.4	124.0	175.0	215.0	248.0	277.0	
-	-	SE	SEV	0.094	79°	484.5	685.1	840.3	969.0	1,082.5	128.0	181.0	222.0	256.0	286.0	
-	-	SE	SEV	0.097	80°	499.6	707.8	866.8	999.2	1,116.6	132.0	187.0	229.0	264.0	295.0	
-	-	SE	SEV	0.100	80°	514.8	726.7	893.3	1,029.5	1,150.6	136.0	192.0	236.0	272.0	304.0	
-	-	SE	SEV	0.103	81°	529.9	749.4	919.8	1,059.8	1,184.7	140.0	198.0	243.0	280.0	313.0	
-	-	SF	SFV	0.106	76°	722.9	1,022.0	1,252.8	1,445.9	1,616.2	191.0	270.0	331.0	382.0	427.0	

Contact our Helpline for any special requirements: Tel: +44 (0)151 424 6821 or inside USA Toll Free: 1-800 DELAVAN  
E-mail: delavanspray@goodrich.com or sales@delavan.co.uk • Web: www.delavan.com

# Capacity Chart

Metering Sets					Spray Angle Measured (1000 PSIG) with water	SDX, SDX III, SDX V, MINI SDX and Compact SDX Capacity Chart									
Swirl Chamber				Orifice		Flow rate in Litres/ HR at Bar G					Flow rate in US GPH at PSIG				
Mini SDX	Compact SDX	SDX & SDX III	SDX V	Equivalent Orifice Dia. (in)		69	138	207	276	345	1000	2000	3000	4000	5000
-	-	SF	SFV	0.109	76°	749.4	1,059.8	1,298.3	1,498.9	1,676.8	198.0	280.0	343.0	396.0	443.0
-	-	SF	SFV	0.112	77°	768.4	1,086.3	1,332.3	1,536.7	1,718.4	203.0	287.0	352.0	406.0	454.0
-	-	SF	SFV	0.115	77°	787.3	1,112.8	1,362.6	1,574.6	1,760.0	208.0	294.0	360.0	416.0	465.0
-	-	SF	SFV	0.118	78°	813.8	1,150.6	1,408.0	1,627.6	1,820.6	215.0	304.0	372.0	430.0	481.0
-	-	SG	SGV	0.121	73°	1,003.0	1,419.4	1,737.3	2,006.1	2,244.5	265.0	375.0	459.0	530.0	593.0
-	-	SG	SGV	0.124	73°	1,025.7	1,449.7	1,775.2	2,051.5	2,293.7	271.0	383.0	469.0	542.0	606.0
-	-	SG	SGV	0.127	74°	1,052.2	1,487.5	1,824.4	2,104.5	2,354.3	278.0	393.0	482.0	556.0	622.0
-	-	SG	SGV	0.130	75°	1,078.7	1,525.4	1,869.8	2,157.5	2,411.0	285.0	403.0	494.0	570.0	637.0
-	-	SG	SGV	0.133	75°	1,105.2	1,563.2	1,915.2	2,210.4	2,471.6	292.0	413.0	506.0	584.0	653.0
-	-	SH	SHV	0.136	70°	1,567.0	2,214.2	2,713.8	3,134.0	3,504.9	414.0	585.0	717.0	828.0	926.0
-	-	SH	SHV	0.140	71°	1,627.6	2,301.3	2,819.8	3,255.1	3,641.2	430.0	608.0	745.0	860.0	962.0
-	-	SH	SHV	0.145	72°	1,703.3	2,407.3	2,948.5	3,406.5	3,807.7	450.0	636.0	779.0	900.0	1,006.0
-	-	SH	SHV	0.150	73°	1,760.0	2,490.5	3,046.9	3,520.1	3,936.4	465.0	658.0	805.0	930.0	1,040.0
-	-	SH	SHV	0.155	74°	1,816.8	2,570.0	3,145.3	3,633.6	4,061.3	480.0	679.0	831.0	960.0	1,073.0
-	-	SI	SIV	0.160	70°	2,043.9	2,891.7	3,539.0	4,087.8	4,568.5	540.0	764.0	935.0	1,080.0	1,207.0
-	-	SI	SIV	0.165	71°	2,195.3	3,103.7	3,803.9	4,390.6	4,909.1	580.0	820.0	1,005.0	1,160.0	1,297.0
-	-	SI	SIV	0.170	72°	2,346.7	3,319.4	4,065.1	4,693.4	5,246.0	620.0	877.0	1,074.0	1,240.0	1,386.0
-	-	SI	SIV	0.175	73°	2,460.3	3,478.4	4,261.9	4,920.5	5,499.6	650.0	919.0	1,126.0	1,300.0	1,453.0
-	-	SI	SIV	0.180	74°	2,554.9	3,614.7	4,424.7	5,109.8	5,711.6	675.0	955.0	1,169.0	1,350.0	1,509.0
-	-	SI	SIV	0.185	75°	2,649.5	3,747.2	4,587.4	5,299.0	5,923.5	700.0	990.0	1,212.0	1,400.0	1,565.0
-	-	SJ	SJV	0.190	71°	3,293.0	4,655.6	5,704.0	6,585.9	7,361.8	870.0	1,230.0	1,507.0	1,740.0	1,945.0
-	-	SJ	SJV	0.195	72°	3,368.7	4,765.3	5,836.5	6,737.3	7,532.2	890.0	1,259.0	1,542.0	1,780.0	1,990.0
-	-	SJ	SJV	0.200	73°	3,463.3	4,897.8	5,999.2	6,926.6	7,744.1	915.0	1,294.0	1,585.0	1,830.0	2,046.0
-	-	SJ	SJV	0.205	74°	3,633.6	5,136.2	6,294.5	7,267.2	8,126.4	960.0	1,357.0	1,663.0	1,920.0	2,147.0
-	-	SJ	SJV	0.210	75°	3,785.0	5,352.0	6,555.6	7,570.0	8,463.3	1,000.0	1,414.0	1,732.0	2,000.0	2,236.0

Note: DELAVAN's SDX® Family of nozzles is protected by Patent.

This chart is a limited illustration, with over a 1000 orifice and swirl chamber combinations, the SDX® can provide multiple flow rates and spray angles at various operating parameters. All spray angles are based on water at a pressure of 1000 psi (69 Bar). The Mini SDX has a nominal spray angle of 70° to 75° due to its unique coned face orifice.

Delavan's Star Rating System (SRS) outlines three primary properties of wear on our Carbide Products; Abrasion, Corrosion and Erosion. Scale (Lowest Rating (\*) to Highest Rating (\*\*\*\*\*))

### Delavan Carbide Reference Guide

Delavan Reference	Carbide Description	* SRS RATING		
		Abrasion	Corrosion	Erosion
Standard Grade	General Purpose Tungsten Carbide used in all of Delavan's SDX products and suitable for most applications.	***	***	***
Standard Plus Grade	General Purpose Tungsten Carbide with improved resistance for use with High Pressure applications.	****	****	****
Premium Grade	Speciality Tungsten Carbide best suited for Chemical and Abrasion Resistance.	*****	****	*****
Superior Grade	Speciality Tungsten Carbide best suited for pure Chemical Resistance with Caustic or Acid materials.	**	*****	****

Delavan Reference: The SDX Family of products comes with carbide internal components made from our Standard Grade of Carbide which is noted by our part numbers. Please contact Delavan for questions on our complete line of material selections.

\* Caution: These ratings are subject to each application and should be used as a general guide.



# Component Parts

## MINI SDX



### SEAL KIT (24 O-RINGS)

Part No.	Description	Material
A49109005	Mini SDX Seal Kit	Viton

22mm  
(0.87")  
DIA

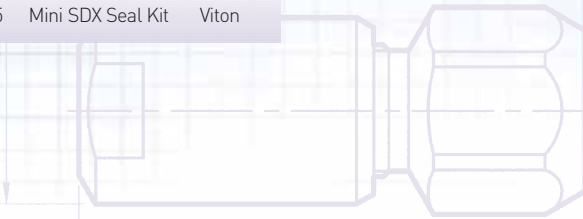

60mm (2.36")

E

D

ADAPTOR

O-RING

C

SWIRL  
CHAMBER

ORIFICE  
DISC

A

BODY

### MINI SDX DESCRIPTION AND PART NUMBERS

Description	Part No.	Material
(A) Body	A329320020	Stainless Steel
(B) Orifice Disc	A00902-XXX*	Tungsten Carbide
(C) Swirl Chamber	See Swirl Chamber Chart below	
(D) O-Ring	A313520130	Viton
(E) 1/4 NPTF Adaptor	A329310013	Stainless Steel
(E) 3/8 NPTF Adaptor	A329310021	Stainless Steel
Assembly Tool	A363860006	Stainless Steel

\* Specify Orifice Size from Capacity Chart, on page 5

**Please note** special materials are available on request for particular applications - please contact the factory for price and delivery.

### MINI SDX SWIRL CHAMBER PART NUMBERS

	Tungsten Carbide	Ceramic
SW1	A507910014	A329330011
SW2	A507910022	A329330029
SW3	A507910030	A329330037
SW4	A507910048	A329330045

### MINI SDX Assembly Procedure:

1. Place the nozzle body (A) thread side up on to a flat surface.
2. Press the orifice disc (B) cone face down into the body.
3. Hand tighten the orifice disc (B) with the assembly/disassembly tool P/N 36386.
4. Place adaptor o-ring (D) onto recess on adaptor (E).
5. Slot the adaptor (E) inlet thread side down and place the swirl chamber (C) swirl side down into the adaptor (E).
6. Place the nozzle body (A) over the swirl chamber (C) and adaptor (E) and screw together and hand tighten only (no tools).
7. Ensure the complete assembly does not rattle.

### ASSEMBLY TOOL

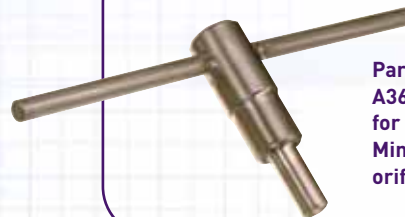

Part number  
**A363860006**  
for changing  
Mini-SDX  
orifice discs.



## SDX



### SEAL KIT (10 OF EACH O-RING)

Part No.	Description	Material
A299630010	SDX Seal Kit	Nylon
A299630036	SDX Seal Kit	Aluminium
A299630044	SDX Seal Kit	Copper
A299630069	SDX Seal Kit	PTFE
A299630077	SDX Seal Kit	Hard Fibre

72.6mm (2.86")

### SDX DESCRIPTION AND PART NUMBERS

Description	Part No.	Material	
(A) Body	A297760017	Stainless Steel	
(B) Orifice O-Ring	A297720011 A297720037 A297720060 A297720078 A297720086 A297720045	Nylon Aluminium PTFE Hard Fibre Stainless Steel Copper	
(C) Orifice Disc	A00703-XXX*	Tungsten Carbide	
(D) Swirl Chamber	See Swirl Chamber Charts below		
(E) End Plate	W053660012	Tungsten Carbide	
(F) Screw Pin	A297770016	Stainless Steel	
(G) Body O-Ring	A297730010 A297730036 A297730069 A297730077 A297730044	Nylon Aluminium PTFE Hard Fibre Copper	
(H) Adaptor	BSPT Thread	NPT Thread	
1/4 Adaptor	A297750091	A297750018	Stainless Steel
3/8 Adaptor	A297750117	A297750034	Stainless Steel
1/2 Adaptor	A297750133	A297750059	Stainless Steel
3/4 Adaptor	A297750158	A297750075	Stainless Steel
Thread Guard	A505190007		Stainless Steel
Removal Tool	W153070005		DurAl

\* Specify orifice size and swirl chamber suffix from capacity chart, on page 5

**Please note** special materials are available on request for particular applications - please contact the factory for price and delivery.

### SDX & SDX III SWIRL CHAMBER/END PLATE COMBINED DESCRIPTION AND PART NO.

	Tungsten Carbide
SW/CH/END PLATE SA	W013800013
SW/CH/END PLATE SB	W013800021
SW/CH/END PLATE SC	W013800039
SW/CH/END PLATE SD	W013800047
SW/CH/END PLATE SE	W013800054
SW/CH/END PLATE SF	W013800062
SW/CH/END PLATE SG	W013800070
SW/CH/END PLATE SH	W013800088
SW/CH/END PLATE SI	W013800096
SW/CH/END PLATE SJ	W013800104
SW/CH/END PLATE SK	W013800120
SW/CH/END PLATE SM	W013800138

### SDX & SDX III SWIRL CHAMBER PART NUMBERS

	Tungsten Carbide	HSS
SW/CH SA	A312120015	A297940015
SW/CH SB	A312120023	A297940023
SW/CH SC	A312120031	A297940031
SW/CH SD	A312120049	A297940049
SW/CH SE	A312120056	A297940056
SW/CH SF	A312120064	A297940064
SW/CH SG	A312120072	A297940072
SW/CH SH	A312120080	A297940080
SW/CH SI	A312120098	A297940098
SW/CH SJ	A312120106	A297940106
SW/CH SK	A312120122	A297940122
SW/CH SL	No Part Number	A297940114
SW/CH SM	A312120130	A297940130

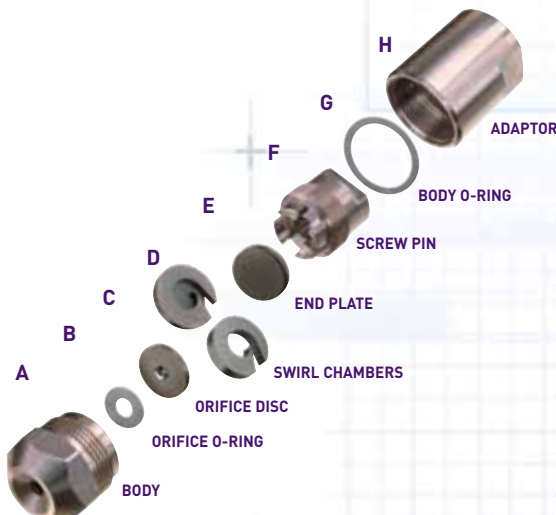

### SDX Assembly Procedure:

1. Place the nozzle body (A) thread side up on a flat surface.
2. Place the orifice o-ring (B) in the nozzle body (A).
3. Place the orifice disc (C) on top of the orifice o-ring (B).
4. Place the swirl chamber (D) on top of the orifice disc (C) it does not matter which direction.
5. Insert end plate (E) over swirl chamber (D) with bevelled side up.
6. Install screw pin (F) into nozzle body (A). Wrench until snug (Torque of 47.5 Newton/Meters or 30-35 foot pounds).
7. Drop the body o-ring (G) on nozzle body (A).
8. Screw the nozzle body assembly onto Adaptor (H). Wrench the nozzle body assembly onto Adaptor (H) until snug. (Torque 68 Newton/Metres or 70-75 foot pounds).
9. Ensure the complete assembly does not rattle.

# Component Parts

## SDX III



### SEAL KIT (10 OF EACH O-RING)

Part No.	Description	Material
A487250001	SDX III Seal Kit	Silicone
A487250027	SDX III Seal Kit	Viton

### SDX & SDX III SWIRL CHAMBER/END PLATE COMBINED DESCRIPTION AND PART NO.

	Tungsten Carbide
SW/CH/END PLATE SA	W013800013
SW/CH/END PLATE SB	W013800021
SW/CH/END PLATE SC	W013800039
SW/CH/END PLATE SD	W013800047
SW/CH/END PLATE SE	W013800054
SW/CH/END PLATE SF	W013800062
SW/CH/END PLATE SG	W013800070
SW/CH/END PLATE SH	W013800088
SW/CH/END PLATE SI	W013800096
SW/CH/END PLATE SJ	W013800104
SW/CH/END PLATE SK	W013800120
SW/CH/END PLATE SM	W013800138

SDX III DESCRIPTION AND PART NUMBERS			
Description	Part No.	Material	
(A) Body	W113000001	Stainless Steel	
(A) Body	A48440	17-4 PH Stainless Steel	
(B) Orifice O-Ring	W155100164 A313520163	Silicone Viton	
(C) Orifice Disc	A00703-XXX*	Tungsten Carbide	
(D) Swirl Chamber	See Swirl Chamber Charts below		
(E) End Plate	A383310016	Tungsten Carbide	
(F) Adaptor O-Ring	W155100214 A313510321	Silicone Viton	
(G) Adaptor	BSPT THREAD	NPT THREAD	
1/4 Female Adaptor	W113011339	A383290015	Stainless Steel
3/8 Female Adaptor	W113012337	A383290028	Stainless Steel
1/2 Female Adaptor	W113013335	A383290036	Stainless Steel
3/4 Female Adaptor	W113014333	A383290044	Stainless Steel
Thread Guard	A505190007	Stainless Steel	
Assembly Tool	W153070005	DurAl	

\* Specify Orifice Size from Capacity Chart, on page 5.

**Please note** special materials are available on request for particular applications - please contact the factory for price and delivery.

### SDX & SDX III SWIRL CHAMBER PART NUMBERS

	Tungsten Carbide	HSS
SW/CH SA	A312120015	A297940015
SW/CH SB	A312120023	A297940023
SW/CH SC	A312120031	A297940031
SW/CH SD	A312120049	A297940049
SW/CH SE	A312120056	A297940056
SW/CH SF	A312120064	A297940064
SW/CH SG	A312120072	A297940072
SW/CH SH	A312120080	A297940080
SW/CH SI	A312120098	A297940098
SW/CH SJ	A312120106	A297940106
SW/CH SK	A312120122	A297940122
SW/CH SL	No Part Number	A297940114
SW/CH SM	A312120130	A297940130

### SDX III Assembly Procedure:

- Place the body (A) thread side up on a flat surface.
- Make sure the orifice o-ring (B) is pressed snugly to the nozzle body (A).
- Place the orifice disc (C) with bevelled side down into the body (A).
- Use your finger to align the orifice into the recessed area in the body.
- Place the swirl chamber (D) on top of the orifice (C). It does not matter which side of the swirl chamber faces the orifice (W0138 will only go one way).
- The direction of the swirl chamber does not affect the functionality of the nozzle.
- If you require an end plate (E), place it circular side down, on top of the swirl chamber (D) with the square side of the end plate on top.
- Make sure the adaptor o-ring (F) is on the adaptor (G).
- Screw the adaptor (G) onto the nozzle body (A) and hand tighten only.
- Ensure the complete assembly does not rattle.

### ASSEMBLY TOOL



Part number **W153070005** for insertion and removal of SDX III swirl chambers.

There is an additional tool number W15336 which is designed for removal of orifice discs which have become embedded with product.

## COMPACT SDX



### COMPACT SDX DESCRIPTION AND PART NUMBERS

Description	Part No.	Material
(A) Body	W203010035	Stainless Steel
(B) Orifice O-Ring	A313520148 W155100149	Viton Silicone
(C) Orifice Disc	W20303-XXX*	Tungsten Carbide
(D) Swirl Chamber	See Swirl Chamber Chart below	
(E) Swirl Chamber Retainer	W203070013	Stainless Steel
(F) Adaptor O-Ring	A313520148 W155100149	Viton Silicone
(G) Adaptor	W203020034	Stainless Steel
Thread Guard	W203230013	Stainless Steel
Compact/Mini Interface Adaptor	W203220014	Stainless Steel
Removal Tool	W203080012	DurAl

### SEAL KIT (12 OF EACH O-RING)

Part No.	Description	Material
W203050015	Compact SDX Seal Kit	Viton
W203060014	Compact SDX Seal Kit	Silicone

\* Specify Orifice Size from Capacity Chart, on page 5.

**Please note** special materials are available on request for particular applications - please contact the factory for price and delivery.

### COMPACT SDX SWIRL CHAMBER PART NUMBERS

	Part Number	Material
SWIRL CHAMBER SA	W203040016	TUNGSTEN CARBIDE
SWIRL CHAMBER SB	W203040024	TUNGSTEN CARBIDE
SWIRL CHAMBER SC	W203040032	TUNGSTEN CARBIDE
SWIRL CHAMBER SD	W203040040	TUNGSTEN CARBIDE

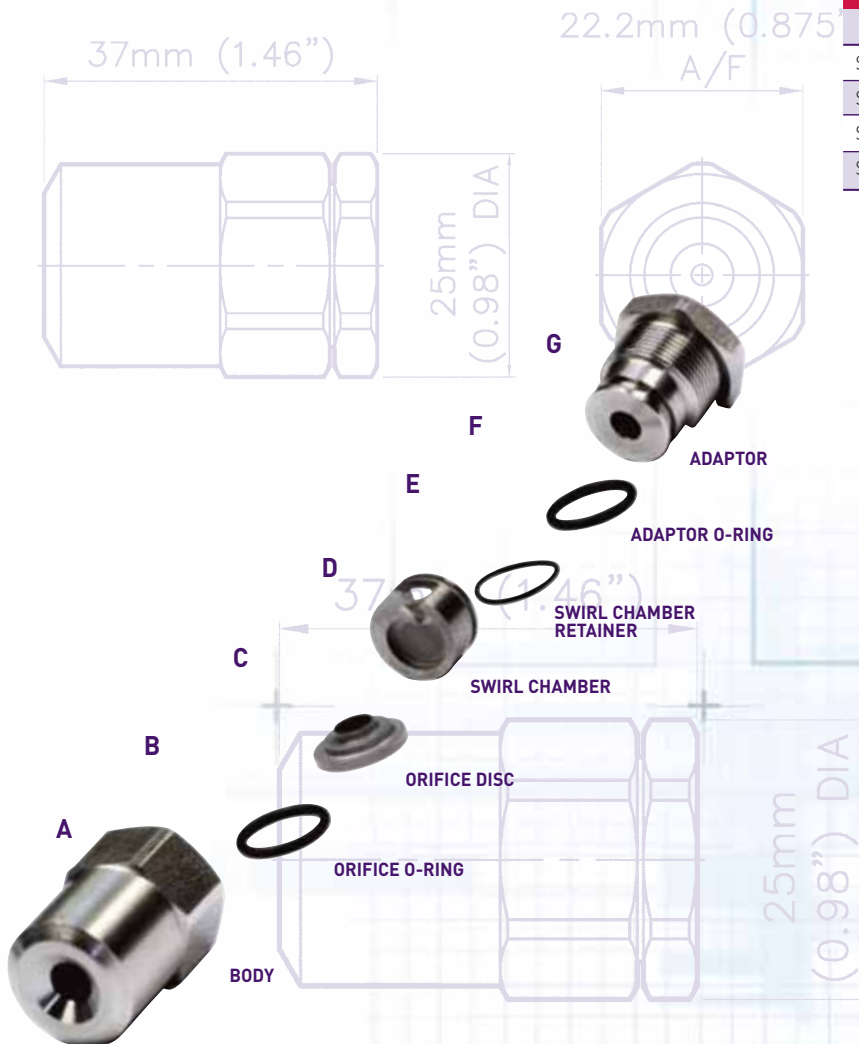

### Compact SDX Assembly Procedure:

1. Place the nozzle body (A) thread side up on a flat surface.
2. Place the orifice o-ring (B) into nozzle body (A).
3. Place the orifice disc (C) onto the orifice o-ring (B) protruding side down.
4. Secure the swirl chamber retainer (E) onto the swirl chamber (D).
5. Place swirl chamber assembly (D + E) swirl end down onto the orifice disc (C) into nozzle body (A).
6. Secure the adaptor o-ring (F) into recess on adaptor (G).
7. Screw down adaptor (G) into nozzle body (A) securing all components in place and hand tighten only.



# Component Parts

## SDX V



### SEAL KIT (12 OF EACH O-RING)

Part No.	Description	Material
W197690016	SDX V Seal Kit	Viton
W197690024	SDX V Seal Kit	Silicone

SDX V DESCRIPTION AND PART NUMBERS			
Description	Part No.	Material	
(A) Body	W194990013	Stainless Steel	
(B) Orifice O-Ring	W155100164 A313520163	Silicone Viton	
(C) Orifice Disc	W19581-XXX*	Tungsten Carbide	
(D) Swirl Chamber	See Swirl Chamber Chart below		
(E) Retainer O-Ring	W155100180 A313520189	Silicone Viton	
(F) Retaining Disc	W195490013	Stainless Steel	
(G) Body O-Ring	W155100222 A31350221	Silicone Viton	
(H) Adaptor	BSPT THREAD	NPT THREAD	
1/4 SDX V Adaptor	W195000010	W196350018	Stainless Steel
3/8 SDX V Adaptor	W195000028	W196350026	Stainless Steel
1/2 SDX V Adaptor	W195000036	W196350034	Stainless Steel
3/4 SDX V Adaptor	W195000044	W196350042	Stainless Steel
Removal Tool	W196440025	DurAl	
SDX Interface Adaptor	W19636	Stainless Steel	
SDX II and III Interface Adaptor	W19637	Stainless Steel	

\* Specify Orifice Size from Capacity Chart, on page 5.

**Please note** special materials are available on request for particular applications - please contact the factory for price and delivery.

### SDX V SWIRL CHAMBER PART NUMBERS

	Part Number	Material
SWIRL CHAMBER SA	W194720014	TUNGSTEN CARBIDE
SWIRL CHAMBER SB	W194720022	TUNGSTEN CARBIDE
SWIRL CHAMBER SC	W194720030	TUNGSTEN CARBIDE
SWIRL CHAMBER SD	W194720048	TUNGSTEN CARBIDE
SWIRL CHAMBER SE	W194720055	TUNGSTEN CARBIDE
SWIRL CHAMBER SF	W194720063	TUNGSTEN CARBIDE
SWIRL CHAMBER SG	W194720071	TUNGSTEN CARBIDE
SWIRL CHAMBER SH	W194720089	TUNGSTEN CARBIDE
SWIRL CHAMBER SI	W194720097	TUNGSTEN CARBIDE
SWIRL CHAMBER SJ	W194720105	TUNGSTEN CARBIDE

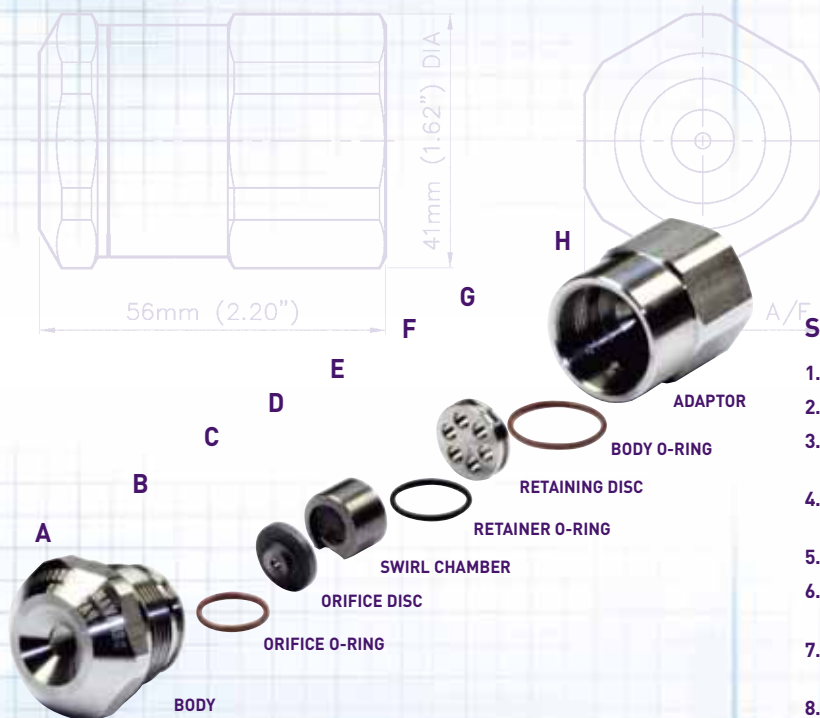

### SDX V Assembly Procedure:

1. Place the nozzle body (A) thread side up on a flat surface.
2. Insert the orifice o-ring (B).
3. Insert the orifice disc (C) into the nozzle body (A) with the "orifice" nose i.e. the smallest diameter first inserted into the body orifice bevelled side up.
4. Place the swirl chamber (D) on top of the orifice disc with the larger diameter flat surface (swirl end) in contact with the orifice disc (C).
5. Ensure that the retainer o-ring (E) is fitted onto the retaining disc (F).
6. Push the retaining disc (F) into the body (A) until the unit is pressed flat against the back face of the swirl chamber (D) and body (A).
7. Place the body o-ring (G) into the body o-ring groove positioned above the threads on the outside of the body (A).
8. Ensure the complete body does not rattle.
9. Pick up the assembled unit and screw into the female adaptor (H) and hand tighten.

## SDX Recommended Cleaning Procedure For All Products

Depending upon your specific application, SDX component parts (orifice, swirl chamber/end plate) and the body, will require cleaning to remove product build up. The frequency of cleaning will depend upon individual applications. In order to maximise the life of the component parts, the following cleaning procedure is recommended:-

Soak the components in a commercially available cleaning solution, using the manufacturer's recommendation on time and concentrate. If making your own, a caustic solution of 20% concentrate or less may be used - but caution should be used, as caustic will eventually affect the component parts.

Parts should not be soaked in caustic solutions overnight, as this may deteriorate the binder used in the tungsten carbide material. Soak no longer than 30 minutes, then rinse thoroughly with water.

Another option is to place the components in an ultrasonic cleaner with water or mild soap for approximately 10-15 minutes, depending upon the cleaning requirements.

This cleaning procedure is appropriate for HSS, tungsten carbide and ceramic materials.

## Cone Faced Bodies and Butt Weld Adaptors

The following are various special bodies, adaptors and tools that are available for the SDX nozzle range.

### CONE FACE BODY



These are designed to prevent build up of sprayed product on the nozzle face and are available with cone angles of 70°, 80° and 90°. Special angles are available on request.

#### CONE FACED BODY PART NUMBERS

Nozzle Type	70°	80°	90°
SDX	A203190010	A203190028	A203190036
SDX III	W118820015	W118820023	W118820031
SDX V	W196000019	W196000027	W196000035

### BUTT WELD ADAPTOR



The nozzle inlet can be provided with a butt-weld connection to suit the customer's existing pipe work sizes in place of the standard thread connection on request.

## Multiple Nozzle Adaptors

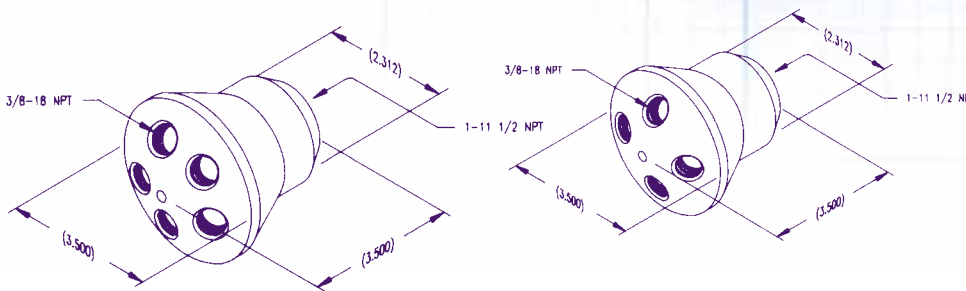

Delavan offers a line of multiple nozzle adaptors for use in applications that require two or more SDX nozzle assemblies. The multi adaptor or cluster body can be used for all models and can be manufactured with a butt-weld or threaded inlet connection to suit customer requirements.

When ordering please state, number of nozzles including the inlet connection size on both the nozzle and adaptor. Please also advise of any dimensional constraints for location of the complete assembly.

## Check Valves

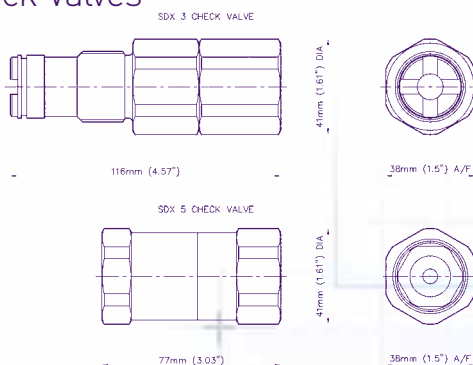

Delavan offers two nozzle check valves that are designed for ease of use, reliable operation and increased profitability. The Delavan Spray Dry Nozzle Check Valves transform our SDX, SDX III and SDX V into an efficient drip-free assembly minimizing clean-up from continued flow after the nozzles have been shut-off. The SDX V check valve is a spring loaded soft seat piston assembly that opens at 3.5 bar (50psi). The SDX III is a ball check valve. Delavan offers two versions of the SDX III check valve, one version that opens at 3.5 bar (50psi) and a second version that opens at 10 bar (145 psi). Both units will stop the flow of media in one direction while allowing flow in the opposite direction.

## Kwik Chek Orifice Gauges



The Kwik-Chek orifice gauges are designed for the rapid measurement of small hole diameters. Models are available to cover a range of hole diameters from 0,010" to 0,255" (0,25mm-6,50mm).

These gauges work on the principle of directly transferring diameter measurements from a sliding, tapered needle to a linear scale readout graduated in 0,001" or 0,02mm.

**Note:-** Kwik-Chek orifice gauge is not suitable for Mini-SDX.

In addition to the SDX™ range of products, Delavan offers further experience through the use of two fluid, or air atomising nozzles.

In two fluid nozzles, air, steam or gas supplies most of the energy to atomise the liquid. This can be mixed either internally or externally using Delavan's Swirl Air Spray Drying Nozzle, this is mixed internally, offering a range of flow rates and spray angles.

Two Swirl-Air nozzle versions are available: the right angle nozzle (atomising air enters the side, the liquid enters axially in back); and the in-line nozzle (concentric-piping is used with the liquid in the centre and atomising air around the outside). A large selection of pipe connections are available including concentric and right angle adaptors with extended lances and manifold mounting being available.

### Features

- Large internal passages with no vanes or cores assure unrestricted flow with little chance for clogging.
- No external struts or supports to interfere with spray pattern.
- Nozzle design provides for vortex mixing, primary impingement, fluid distortion and external impact for fine atomisation and relatively high nozzle efficiency.
- Spray angle can be adjusted through interchangeable nozzle cap assemblies. This feature permits much wider spray patterns than are possible with most types of two fluid atomisers.
- Air flow (M<sup>3</sup>/min) and power requirements are relatively low, permitting specification of smaller air compressors.
- Good atomisation over wide turn-down ratios.
- Droplet size is controlled by minor changes in air pressure.

### Spray Characteristics

- Air is introduced tangentially into the nozzle chamber in low pressure region of the swirling liquid, creating extreme turbulence and primary atomisation. As liquid leaves the orifice, it impinges against the deflector ring which serves a dual purpose: close control of spray angle and breakup of the spray into even finer droplets (secondary atomisation).
- Nominal spray angles of 50°, 75°, 100° can be attained by specification of interchangeable nozzle caps. Contact Delavan's Customer Service Team for special spray angles up to 180°.
- Mean droplet diameters in the 50 to 100 micrometres range at modest air pressures and flow rates.
- Degree of atomisation is also variable by controlling the ratio of air to liquid.
- If air pressure is set initially, and it is necessary to modulate the liquid flow, the air pressure and flow rates will automatically respond in such a way that the quality of atomisation remains nearly constant. In some applications, this can result in savings through the elimination of air valving and controls.



Right Angle Nozzle Assembly



In-Line Nozzle

**Contact our factory for a copy of the new Swirl Air brochure which will be available from August 2006.**



# Spray Drying Fax Back Form



This enquiry sheet serves as a guide so that we may better assist you in proper nozzle selection. Many times the optimum nozzle combination cannot be found on the first attempt but the more completely this form is filled out, the better our chance of success.

Name: \_\_\_\_\_ Date: \_\_\_\_\_

Company: \_\_\_\_\_

Address: \_\_\_\_\_

\_\_\_\_\_

\_\_\_\_\_

Tel No: \_\_\_\_\_ Fax No: \_\_\_\_\_

E-mail: \_\_\_\_\_

## The Feed Material

Substance being sprayed: \_\_\_\_\_ % Solids: \_\_\_\_\_

Specific gravity (or Density): \_\_\_\_\_ Viscosity: \_\_\_\_\_

Acidic or alkaline (pH): \_\_\_\_\_

## The Nozzle

Nozzle type presently being used: \_\_\_\_\_

Manufacturer: \_\_\_\_\_ Number of nozzles: \_\_\_\_\_

Rated flow and spray angle: \_\_\_\_\_ Average wear life: \_\_\_\_\_

Material: \_\_\_\_\_ Thread type: \_\_\_\_\_

## The Dryer

Dryer manufacturer: \_\_\_\_\_ Inlet air temp: \_\_\_\_\_

Cocurrent or countercurrent air: \_\_\_\_\_ Outlet air temp: \_\_\_\_\_

Dryer diameter at nozzle position: \_\_\_\_\_ Maximum pump pressure: \_\_\_\_\_

Pump manufacturer: \_\_\_\_\_ Operating pressure: \_\_\_\_\_

## The Dry Product

% Moisture: \_\_\_\_\_ Density: \_\_\_\_\_

Pounds per hour: \_\_\_\_\_ Solubility: \_\_\_\_\_

Comments: \_\_\_\_\_

\_\_\_\_\_

\_\_\_\_\_

 Please fax back to: **+44 (0)151 495 1043**  
If faxing back from USA: **011 (44) 151 495 1043**  
**or your local distributor**

Delavan Ltd., Gorse Lane, Widnes, Cheshire WA8 0RJ England  
Tel: +44 (0) 151 424 6821 E-mail: sales@delavan.co.uk. Web: www.delavan.co.uk

Contact our Helpline for any special requirements: Tel: +44 (0)151 424 6821 or inside USA Toll Free: 1-800 DELAVAN

# We Don't Just Supply the Nozzles....

Delavan's extensive experience goes beyond just the nozzle with a full range of engineered support for spray lances. Delavan offers a variety of production services to best meet your needs. For new systems, Delavan will handle each stage of development from preliminary design to servicing the product. Delavan can also enhance current designs or simply manufacture products from existing designs. Build to print design services for your application with specifications, Delavan can provide cooled or heated lances, support special mounting flanges, by-pass or purge systems to meet every industry standard. Whether it is FDA or other coded installments e.g. DIN, JIS or ANSI Delavan has the ability to supply.

Standard Designs available for our SDX and Swirl Air products in every Spray Dry application, whether it's Food, Chemical, or Pharmaceutical. Flanged Port or Wall Mounted Fittings prevents splash-out during cleaning. Sanitary Connections mounted to the vessel with automated Clean-In-Place valving provides a simple and reliable process for stringent hygienic operations. Extended Lances with Spray nozzles are available for single-wall, double-wall and insulated vessels.

With years of proven designs, Delavan can support a large range of extended spray lances with multiple materials of construction, with extensive testing capacities.

## Extended Pipe Works and Spray Lances

- Design, development, and modeling.
- Manufacturing prototypes.
- Application testing.
- Overhaul and repair.
- Build to print.
- Product redesign.
- Spray and droplet analysis.

Standard Spray lance features available in 0°, 45° and 90° configurations with competitive pricing and quick delivery.

Typical Spray Dry Lance

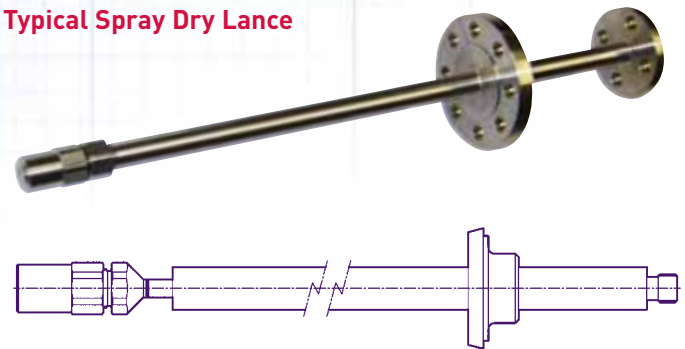

Dealer Stamp

Details of all our products are available on our website @ [www.delavan.com](http://www.delavan.com)

**Delavan Ltd** – Gorsey Lane – Widnes – Cheshire – WA8 ORJ – UK

Telephone: +44 (0) 151 424 6821 Fax: +44 (0) 151 495 1043

Inside USA Toll Free: 1-800 DELAVAN

e-mail: [sales@delavan.co.uk](mailto:sales@delavan.co.uk) or [delavanspray@goodrich.com](mailto:delavanspray@goodrich.com)

Web: [www.delavan.com](http://www.delavan.com)



Certificate No. 3291

Delavan, SDX and the Goodrich Stripes logo are registered trademarks of Delavan Spray Technologies and the Goodrich Corporation respectively ©Delavan Spray Technologies 2004

All materials are the intellectual property of Goodrich and cannot be used without Goodrich's consent